

The Gravity Probe B EXPERIMENT

“Testing Einstein’s Universe”



LOCKHEED MARTIN 

The Enigma of Gravity

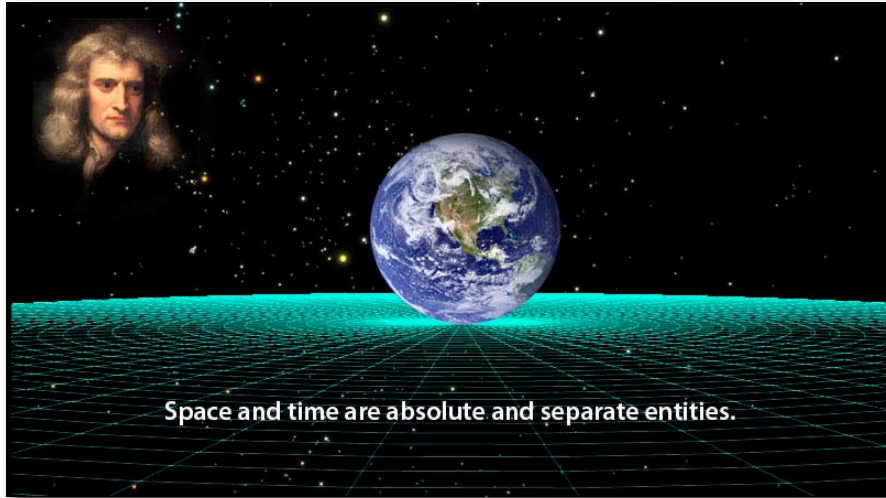

Sir Isaac Newton:

Space and time are absolute or fixed entities. Gravity is a force that acts instantaneously between objects at a distance, causing them to attract one another.

Albert Einstein:

Space and time are relative entities, interwoven into a spacetime fabric whose curvature we call gravity. Spacetime tells matter how to move, and matter tells spacetime how to curve.

A “Simple” Experiment

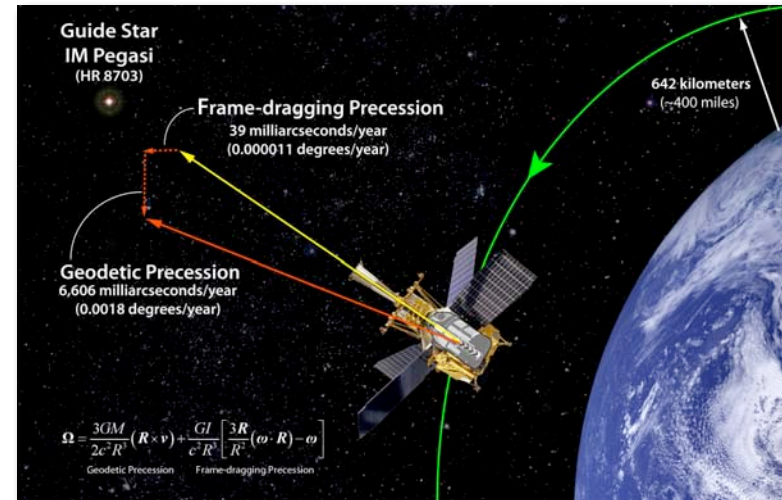
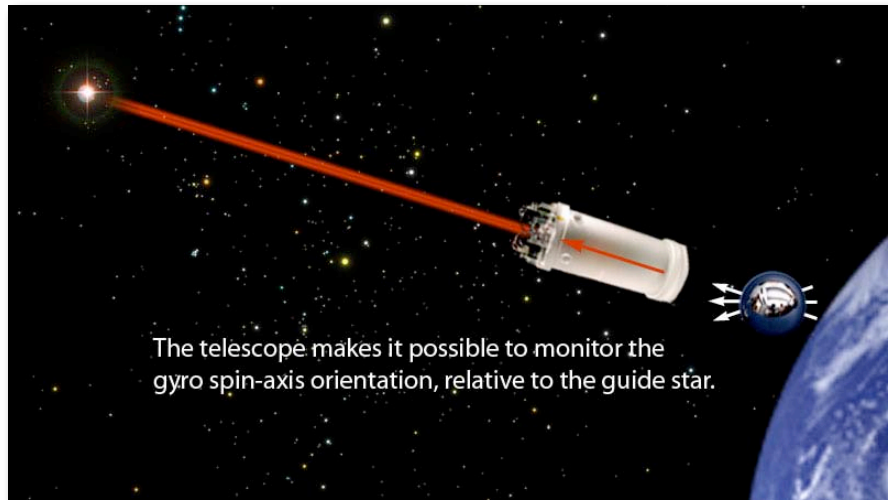

GP-B Co-Founder, Bill Fairbank, once remarked: “No mission could be simpler than GP-B; it’s just a star, a telescope and a spinning sphere.” However, it took over four decades to develop all the cutting-edge technologies necessary to carry out this “simple” experiment.

Ultra-Precise Gyroscopes

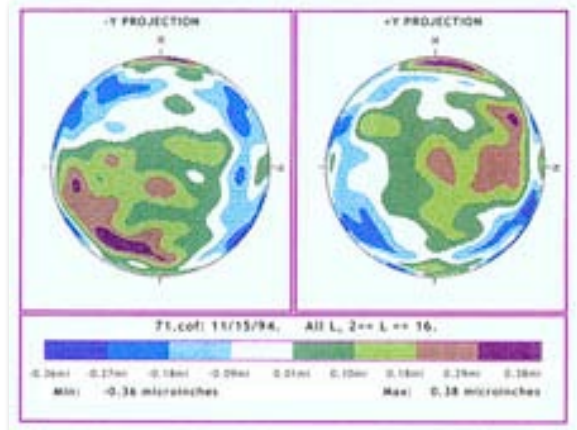

To measure the minuscule angles predicted by Einstein's theory, it was necessary to build near-perfect gyroscopes ~50 million times more precise than the best navigational gyroscopes. The GP-B gyro rotors are listed in the Guinness Database of World Records as the most spherical man-made objects.

SQUID Magnetometers

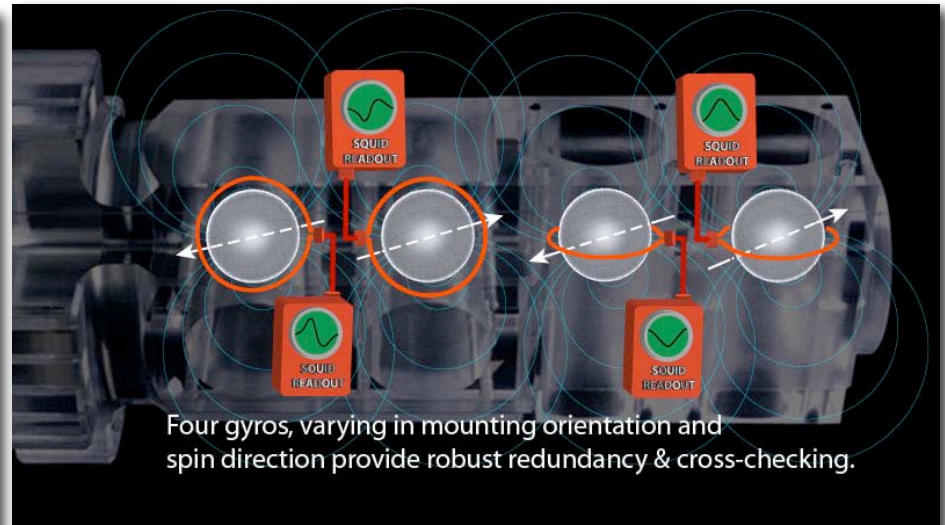
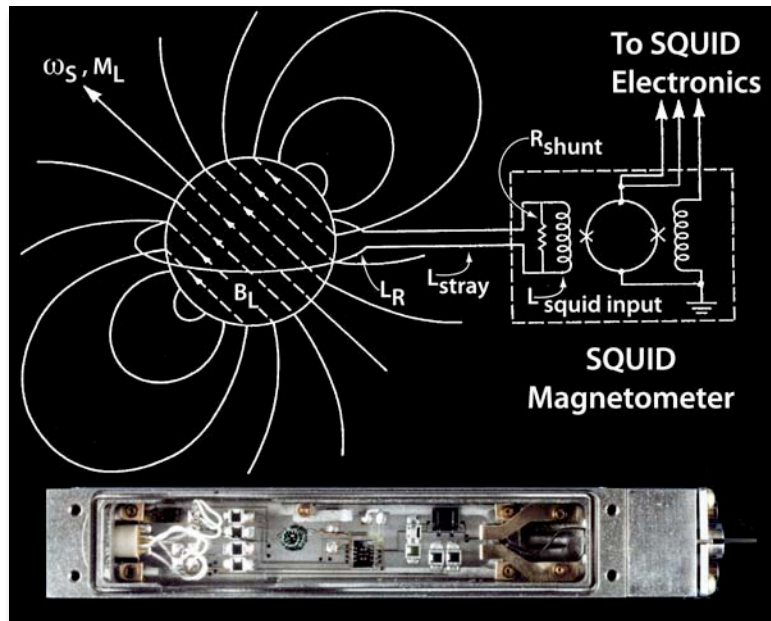

How can one monitor the spin-axis orientation of a near-perfect spherical gyroscope without any physical marker showing the location of the spin axis on the gyro rotor? The answer lies in superconductivity.

Predicted by physicist Fritz London in 1948, and most fortunate for GP-B, a spinning superconductor develops a magnetic moment exactly aligned with its spin axis.

Pointing Telescope



A telescope mounted along the central axis of the dewar and spacecraft provided the experiment's pointing reference to a "guide star." The telescope's image divider precisely split the star's beam into x-axis and y-axis components whose brightness could be compared.

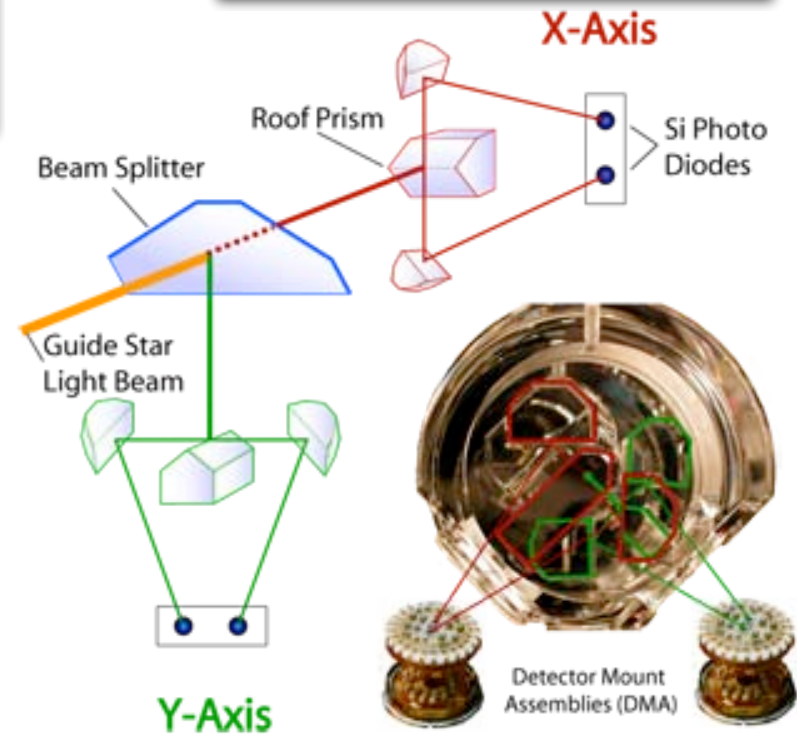
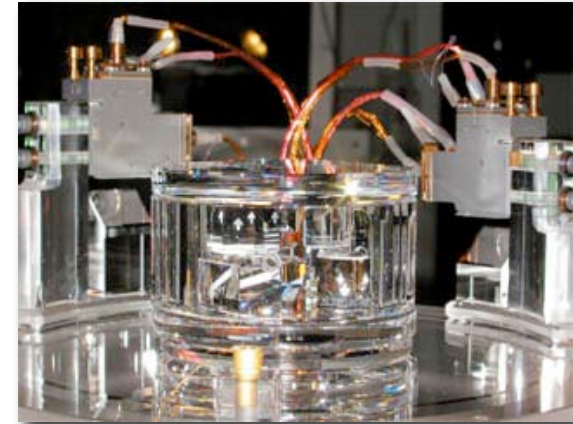

Dewar & Probe

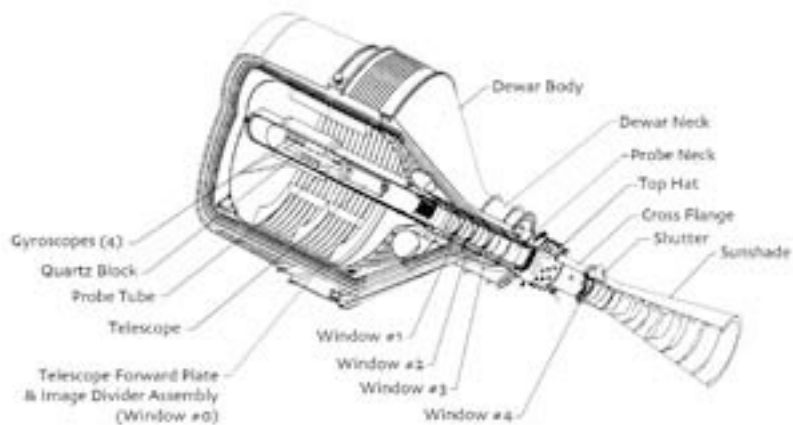
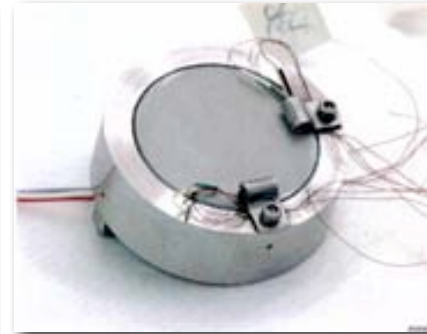

GP-B's 650-gallon dewar, kept the science instrument inside the probe at a cryogenic temperature (2.3K) for 17.3 months and also provided the thruster propellant for precision attitude and translation control.

Integrated Payload & Spacecraft

Built around the dewar, the GP-B spacecraft was a total-integrated system, comprising both the space vehicle and payload, dedicated as a single entity to experimentally testing predictions of Einstein's theory.

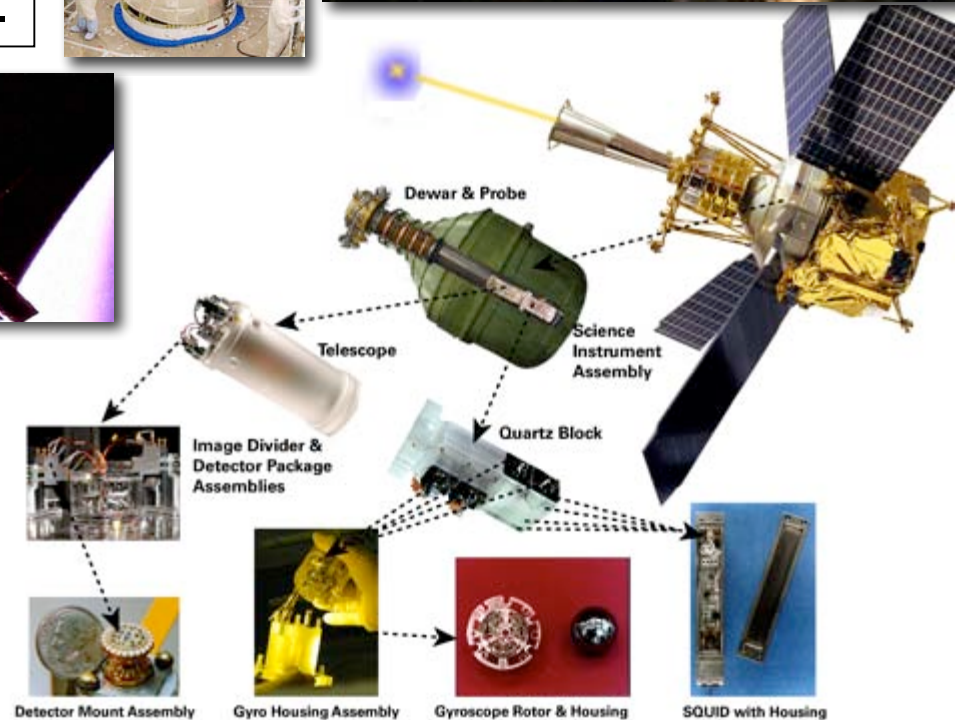
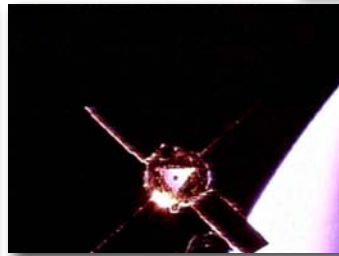
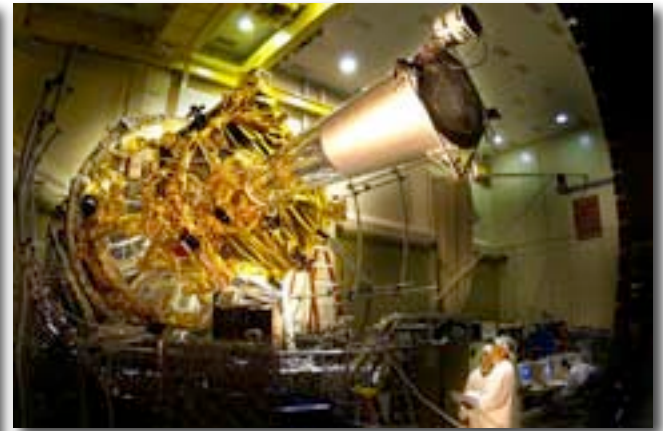

A Collaborative Effort

The success of GP-B required extraordinary collaboration between the Physics and Aero-Astro departments at Stanford and between Stanford, NASA, and Lockheed Martin. In 2005, NASA gave a Group Achievement Award to the entire GP-B team.

